



**finder**<sup>®</sup>  
SWITCH TO THE FUTURE



# LIGHTING MANAGEMENT

**FINDER: Light when you need it**



**LIGHT UP YOUR LIFE WITH FINDER**  
MANAGING YOUR LIGHTING WITH FINDER  
PRODUCTS MEANS A MORE RESTFUL AND  
COMFORTABLE ENVIRONMENT, A MORE  
EFFECTIVE WORKING SPACE AND A MORE  
EFFICIENT USE OF ELECTRICITY

# CONTENTS

YESLY - Comfort living system

8

1L Series - LUMOS emergency light

14

12 Series - Time switches

16

18 Series - Movement and presence detectors

22

14 Series - Staircase timers

26

15 Series - Dimmers

28

10 Series - Light dependent relays for pole or wall mounting

34

11 Series - Modular light dependent relays

36

20 - 26 - 27 Series - Electromechanical step relays

38

13 Series - Electronic step / monostable relays

40

22 Series - Modular contactors

42

78 Series - Switch mode power supplies

44

# ABOUT US

Founded in Italy in 1954, Finder has for decades built a wide range of electromechanical and electronic components for the residential, commercial and service sectors, and the industrial sector. Today, thanks to a global vision, Finder distributes its products around the world through a network of 22 owned subsidiaries and more than 80 trade partnerships.

Finder is an international family made up of more than 1,300 individuals, all united by the same values and passion for our products.

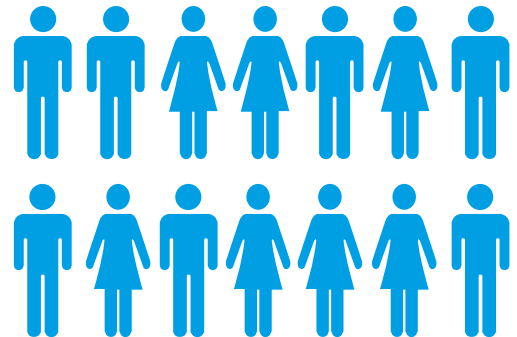

**12,500**

Different products for all kinds of applications. Products at the heart of automation. Products that can respond to electricity; to the time of day; to temperature; water level and ambient light level

OUR PRODUCTS CARRY MORE CERTIFICATIONS THAN ANY OTHER RELAY MANUFACTURER.



## FINDER IS AN ITALIAN BRAND WITH A WORLDWIDE PRESENCE

**4** PRODUCTION PLANTS IN EUROPE

**26** SUBSIDIARIES

**80+** OFFICIAL DISTRIBUTORS



# PRESENTING YESLY. YESLY, TIME FOR COMFORT LIVING

**FINDER YESLY** is the system we have designed to control lighting, electric shutters and many other devices in your home using your smartphone, via wireless buttons or voice commands.

## YESLY IS:

**USER-FRIENDLY:** It requires no intrusive installation work and can perfectly integrate with most home electrical lighting systems.

**MADE IN ITALY:** Italian design and quality manufacture - since 1954.

**CONNECTED:** Controllable from your smartphone or via voice command.

**SAFE:** 128bit encrypted transmission - safe and secure

Start by having your electrician install a Bluetooth multi-function relay or Bluetooth dimmer to control your living room ceiling light, kitchen spotlights or bedroom floor lamp.

In just a few minutes, you'll be able to control your chosen devices via your smartphone. Using the Finder Yesly app, you can switch the lights on and off, adjust their intensity and set a customised scenarios.

Install YESLY products in one or more rooms, according to your needs, to make your home smarter - a little at a time. And for people who like to be always connected, devices can even be controlled remotely via the app, or using voice command via the Google Assistant and Amazon Alexa.

## MAKE YOUR HOME SMARTER IN JUST A FEW QUICK AND EASY STEPS

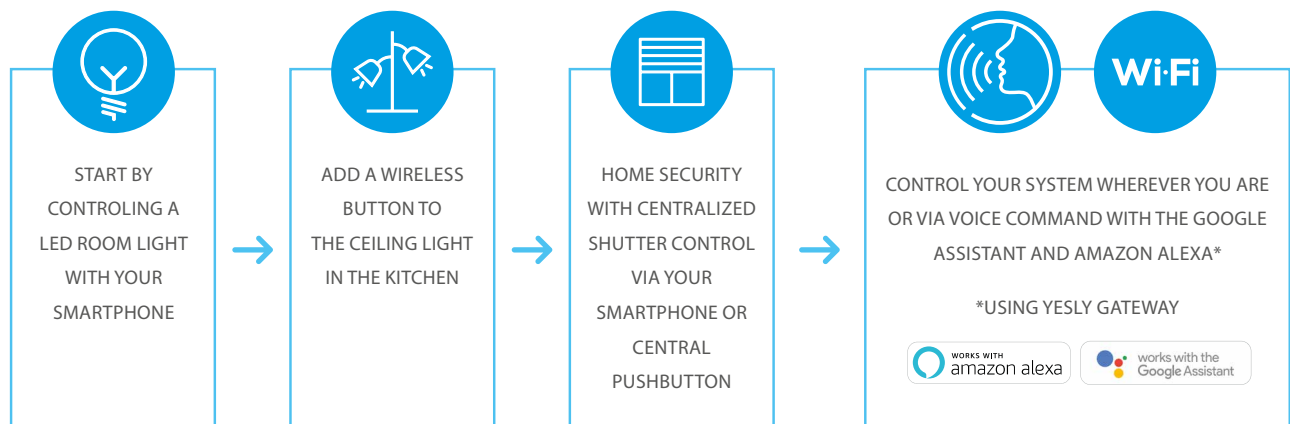

# YESLY

TIME FOR  
COMFORT  
LIVING

## MULTIFUNCTIONAL BLUETOOTH RELAY

The Finder YESLY multi-function relay is the device that allows you to turn the lights **on/off**, activate the **shutters** and **electric blinds**, and much more.



Type 13.72  
INTEGRATABLE



Type 13.22  
RECESSED

- Programmable via app for iOS and Android smartphones
- Compatible with the most common home electrical systems
- Up to 21 functions available
- Immediate control via Bluetooth



Create scenarios



Control up to 2 lights



Control 1 roller shutter



## BLUETOOTH DIMMER

The Finder YESLY universal Bluetooth dimmer allows you to **control the intensity** of lights of different technologies, enhancing your comfort level while minimising energy wastage.

**Perfect for LED lamps** and Dimmable CFLs, halogen lamps, electronic power supplies and much more.



Type 15.71  
INTEGRATABLE



Type 15.21  
RECESSED

- Programmable via app for iOS and Android smartphones
- Automatic compatibility with all dimmable lights
- 7 available functions
- Overheating and short-circuit protection



ON / OFF



Brightness control



Soft Start function



Create scenarios



## SHUTTER ACTUATOR

The Type 13.S2 Actuator is a device specifically designed for **controlling electric shutters and curtains**.

In just a few minutes, **without any masonry work**, **centralize your control of shutters** to activate them via smartphone or voice command (using the YESLY GATEWAY).



Type 13.S2  
RECESSED

Manage from your smartphone immediately  
Centralized opening and closing via smartphone or BEYON button



Wall box mounting



Create scenarios



Control 1 roller shutter



## RANGE EXTENDER

The range extender is a device for extending the range of YESLY devices by around 10 meters in free space.

The ideal solution for large homes.

Available in a plug and play version with USB connector, or in a hidden recessed version.



Type 1Y.EU.005



Type 1Y.E8.230

- Transmission range about 10 meters in free space
- Range can vary depending on the building's structure



Plug & Play  
Installation



Range extension

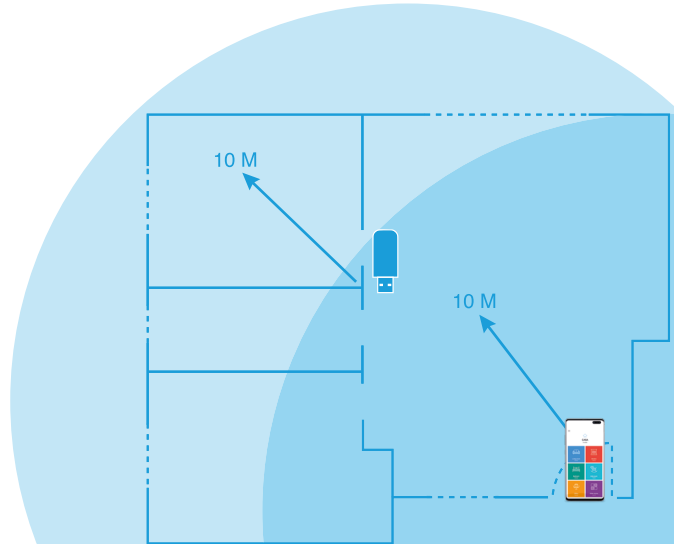

## INPUT INTERFACE

The Type 1Y.P2 Interface Input can transform any pushbutton or switch into a wireless control for the YESLY system. Invisible and integratable into any installed home lighting system.

Perfect for centralizing or controlling individual electric shutters



Type 1Y.P2  
RECESSED

- Can be integrated into all home electrical systems
- Transforms both pushbuttons and switches into wireless controls
- Programmable from a smartphone via app (Android or iOS)



Bluetooth



Adjust and turn  
devices on / off



Create  
scenarios

## GATEWAY

The YESLY GATEWAY allows you to manage the opening or closing of your electric shutters and curtains - or to control your lighting - from a remote location using your smartphone and the Yesly app. It also permits control via voice command using the Google Assistant or Amazon Alexa.

The GATEWAY is a small, elegantly designed, easy-to-install device.

In addition, thanks to Google Assistant and Amazon Alexa, you can integrate YESLY into routines, along with other services offered by voice command assistants.



Remote control via  
Finder Yesly app



Integrates  
commands with  
voice assistants





# BEYON

## WITH BEYON, YOU CAN ADD A BUTTON WHEREVER YOU NEED ONE!

BEYON is a wireless pushbutton that doesn't need a battery or recharging - ever. Use it to turn the lights on and off, to control your electric shutters or to call up your customized SCENARIOS\*, as an alternative to the Finder Yesly app.

Available in single or dual configuration and in multiple colours, adapts to any environment and can be adhered to most surfaces.



\*Transmission range of about 10 meters in free space  
The actual range may vary depending on the building's structure.



Bluetooth



No battery, no charging



Create scenarios



Adjust and turn devices on / off

## WIRELESS BUTTONS

Wall mounted with 2 or 4 channels

Bluetooth wireless buttons are the ideal solution to keep a minimal and discreet look in your home, without sacrificing the YESLY system technology\*.

Available with 2 or 4 channels, no battery or recharging needed; can be assembled on 60mm junction boxes or wall mounted, thanks to a special adhesive.



Type 013B9

\*Transmission range of about 10 meters in free space  
The actual range may vary depending on the building's structure.



## TWO APPS FOR YOUR SMART HOME

Finder Yesly and Finder Toolbox Plus are the YESLY system's two smartphone applications.

With **Finder Yesly** each member of the family can control the lights and electric shutters from their smartphone, calling up customized SCENARIOS. Ideal for creating the most suitable ambiance at any time of day, and easily managing your smart home, even remotely.

With **Finder Toolbox Plus**, any professional installer can quickly configure your system and customize it to your needs in a few simple steps.

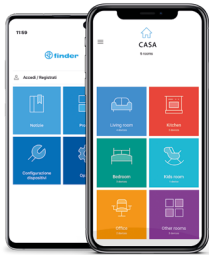

CONTROL CURTAINS /  
ELECTRIC SHUTTERS



TURN LIGHTS ON  
/ OFF



GROUP TOGETHER DEVICES  
BY ROOM



REGULATE LIGHTING



CONFIGURE UP TO 8  
SCENARIOS  
PER DEVICE



CUSTOMISE ALL  
ICONS AND ROOMS IN THE APP



Finder Toolbox



Finder Yesly



Android, Google Play and the Google Play logo are trademarks of Google Inc.  
Apple is a trademark of Apple Inc. App Store is a service mark of Apple Inc.

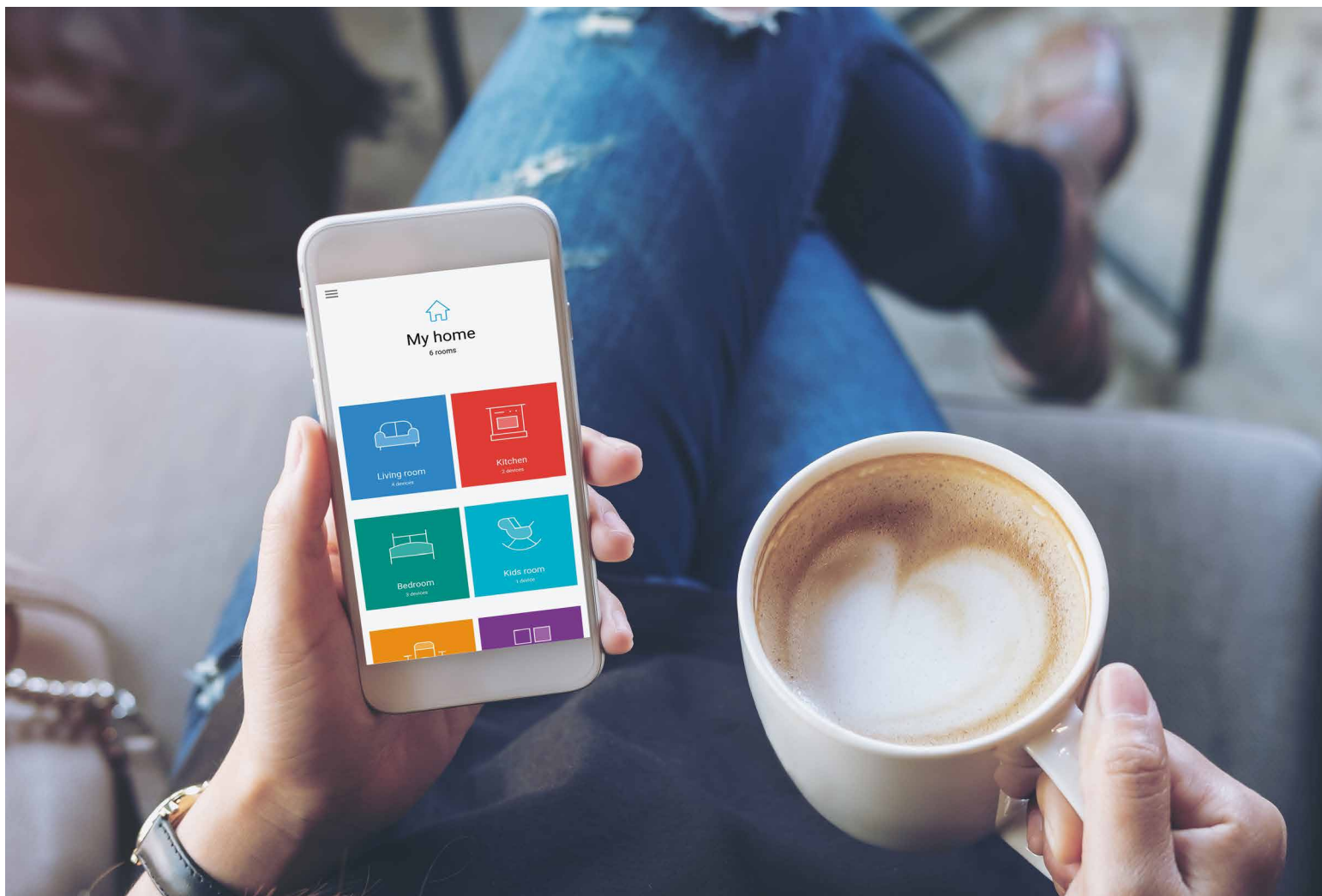

## LUMOS - THE MAGIC OF LIGHT, ONLY WHEN IT 'S NEEDED

The Type 1L.10 LUMOS emergency light enhances safety in the home in the event of a power outage. It has sleek lines and an ultra-flat design.

Perfect for any type of environment and available in two colours (white and anthracite grey), this product looks great and can be integrated in the most popular home and commercial electrical systems.



Emergency light  
Type 1L.10

LUMOS

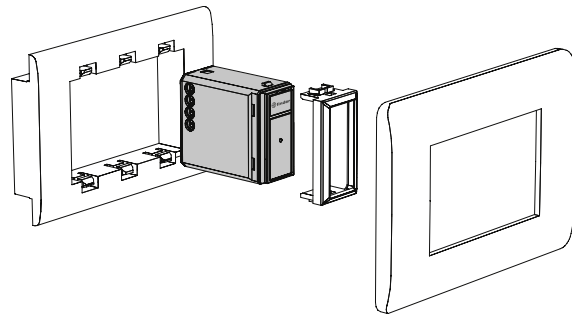

## A COMPLETE RANGE

### ALL THE FUNCTIONS YOU WANT, WITHOUT REQUIRING INVASIVE WORK

The range of Finder products that can be integrated within the type 503 and type 504 wall boxes is completed with the Type 18.91 MOVEMENT DETECTOR, which triggers the lighting on the detection of people in transit.

It is perfect for integration in areas such as indoor garages, toilets, service rooms or corridors, as it is virtually invisible after installation.



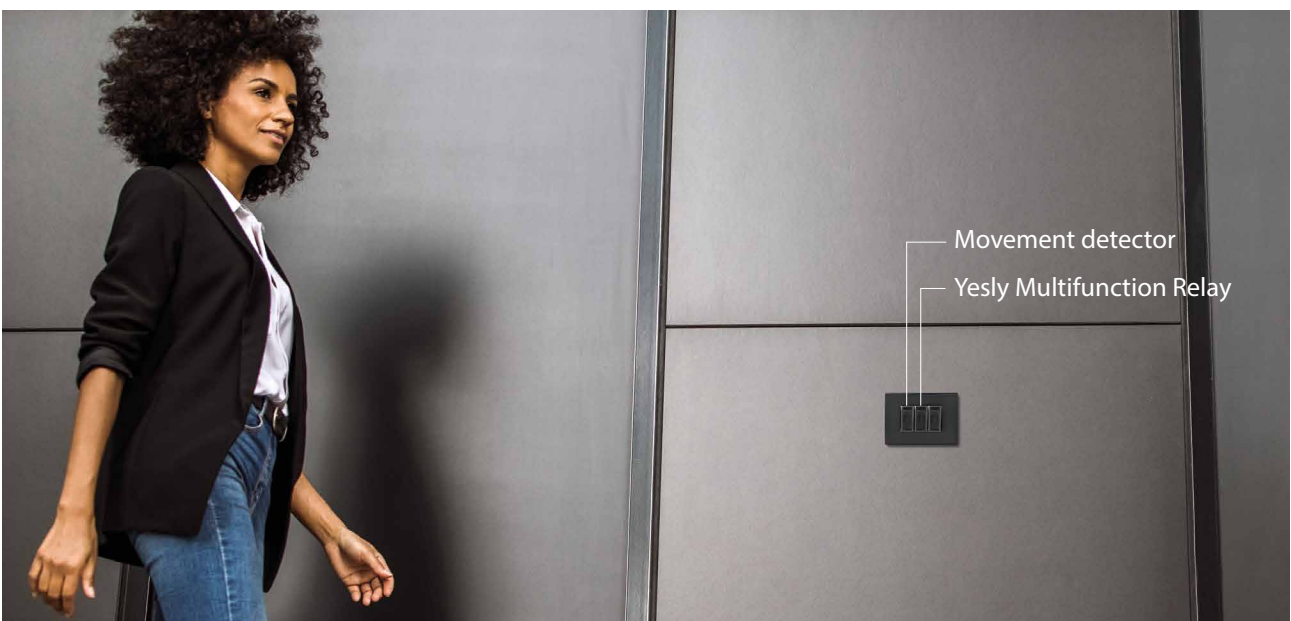
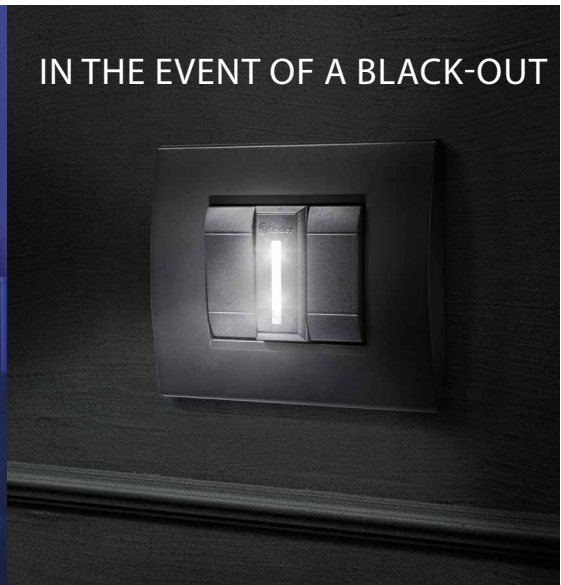
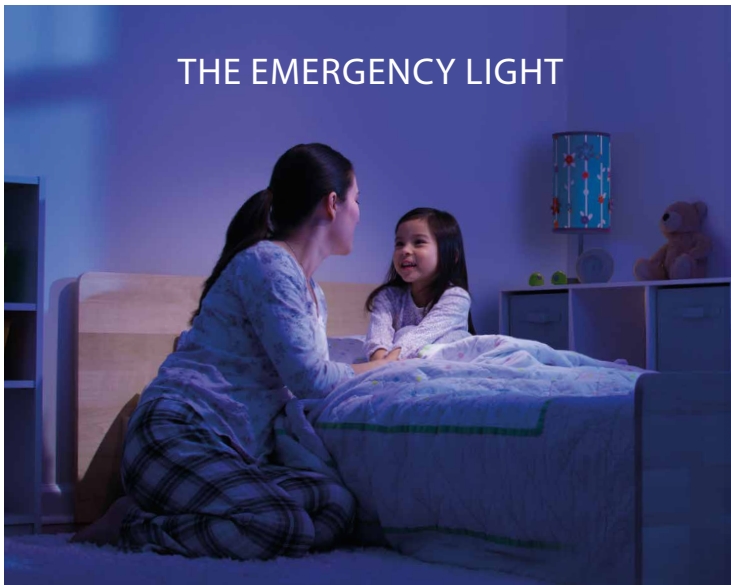

## 12 SERIES.

# PROGRAM YOUR LIGHTING FOR OPTIMUM COMFORT AND ENERGY SAVINGS.

### TIME SWITCHES

To be able to schedule and manage when lighting comes on and goes off in a way that is both optimal and efficient, be it in privately owned spaces such as houses and apartments, or in common areas in apartment buildings and offices such as gardens, garages and entrance halls, according to the time of day and / or geographical location, is exactly what FINDER's 12 SERIES time switches allow you to achieve.

### APPLICATIONS

FINDER 12 SERIES time switches are ideal for programming lighting systems in both public and private areas. From the configuration of garden lights to the integration of street light systems, FINDER 12 SERIES time switches are the perfect tools to create light when you need it!



### MADE IN EUROPE DEPENDABILITY

12 SERIES time switches are manufactured in Italian production plants owned by the FINDER group. All processes are carried out in compliance with an ISO9001 certified production system for quality, in production plants equipped with cutting-edge technology. What does this mean for you? Maximum reliability, service and safety. Guaranteed.

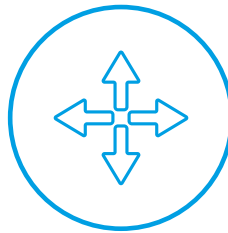

### FLEXIBILITY, TO RESPOND TO ALL YOUR NEEDS

**Whoever said that one solution works for everyone?** With a wide range of functions and the configuration capability of smartphone using the FINDER TOOLBOX APP, FINDER 12 SERIES time switches enable you to program your lighting system down to the tiniest detail, offering the utmost flexibility. Now there's a system that can really suit your needs!

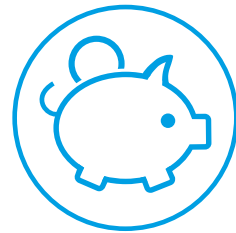

### SAVE TIME, ENERGY AND MONEY

Thanks to its ASTRO program, the FINDER 12 SERIES saves you time, even during installation. Configuring the system via a smartphone is around five times faster than doing it manually. The ASTRO system switches the lighting on and off according to the geographic coordinates of your location and the time of year.

## APPLICATIONS



HOUSES  
OFFICES  
SHOPS  
GARDENS  
GARAGES  
APARTMENTS

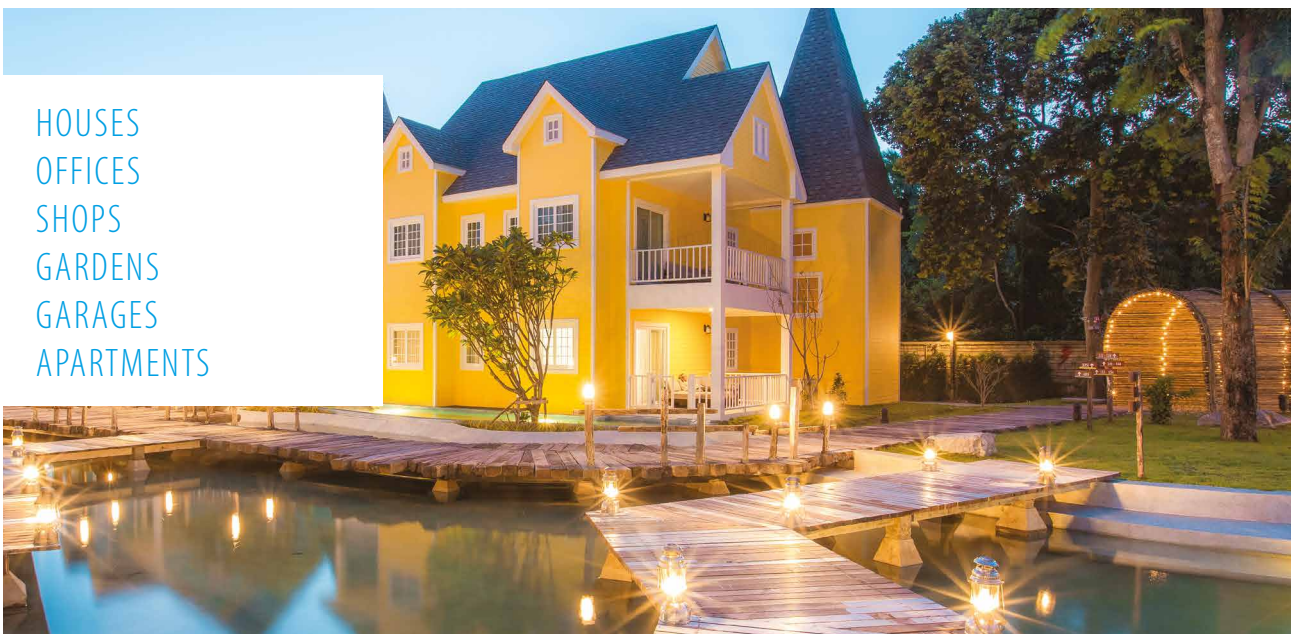

# SMART TIME SWITCHES WITH NFC TECHNOLOGY.

Setting up a timer has never been so simple, with new 'smart' time switches that can be configured via a smartphone.



**12 Series BASIC.**  
Type 12.51 - Type 12.81

- Digital time switch  
Easily configurable for daily / weekly programming (Type 12.51)
- Astro: Easy calculation of sunrise and sunset times through date, time and location coordinates (Type 12.81)



**12 Series DIGIT.**  
Type 12.61 - Type 12.62

- Digital time switch
- Easily configurable for daily / weekly programming
- Minimum switching interval of 1 minute



**12 Series ASTRO.**  
Type 12.A1 - Type 12.A2

- Digital time switch
- Astro: Easy calculation of sunrise and sunset times through date, time and location coordinates
- Easily configurable for daily / weekly programming
- Minimum switching interval of 1 minute



# 12 SERIES

## FUNCTIONS



**ASTRO:**  
Calculates dawn and dusk times based on the date and geographical coordinates.



**ASTRO ON-OFF:**  
Classic on/off function with **AstroON** and **AstroOFF** based on the geographic coordinates



**OFFSET:**  
To bring forward or delay (up to 90 minutes) the switching on and off of the lights in relation to dawn and dusk times.



**ON/OFF:**  
Channel switched to **ON** mode.  
Channel switched to **OFF** mode.



**NIGHT:**  
Programmable on/off times



**IMPULSE:**  
1 s...59 min.

## 'SMART' CONFIGURATION

With the Finder Toolbox app, you can now configure a time switch straight from your smartphone!  
By using the NFC technology (Near Field Communication) that is currently available only on Android smartphones, you can:

- configure the time switch straight from your smartphone
- repeat the same configuration over several days
- save the configuration and apply it to other devices

The Finder Toolbox app brings you the latest news and updates on Finder products at your fingertips.

By downloading the free app, you can configure the following [types: 12.51, 12.81, 12.61, 12.62, 12.A1, 12.A2.](#)

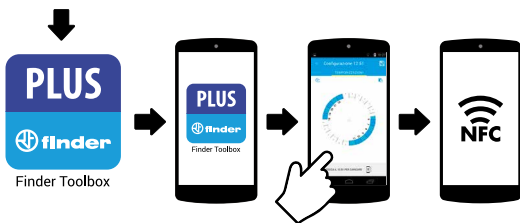
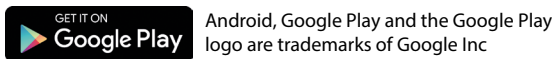





**finder**<sup>®</sup>  
SWITCH TO THE FUTURE

FINDER HAS BEEN DESIGNING AND  
DEVELOPING LIGHTING MANAGEMENT  
PRODUCTS FOR MORE THAN 60 YEARS



## 18 SERIES.

# PROGRAM YOUR LIGHTING TO RESPOND TO MOTION WITH FINDER'S MOVEMENT AND PRESENCE DETECTORS.

### WHY CHOOSE FINDER'S PRESENCE AND MOVEMENT DETECTORS?



#### SAFETY

Finder's movement detectors will automatically and immediately **switch on the lights as soon as someone passes through the area**. This means that there is no need to install light switches, especially in communal areas such as garages and staircases. In addition, when fitted in strategic locations and when correctly integrated with a lighting system, the movement detectors can serve as a deterrent for intruders.



#### COMFORT

**All the light you need, only when you need it.** This is the philosophy that Finder designers kept in mind when developing their movement and presence detectors. Thanks to the wide area of survey, the sensitivity of the lenses and the effective integration with the lighting system, Finder detectors guarantee unbeatable comfort and convenience. Gone are the days scrabbling around in the dark for the light switch in the garage or on the staircase: **light now follows your every move!**



#### ENERGY SAVINGS

Finder detectors ensure that your lights are switched on only when strictly necessary. This will naturally bring **substantial energy savings**, in heavily transited areas, and in places that are used at specific times, such as schools, offices, corridors, staircases, garages and more.



# 18 SERIES

# LIGHT WHENEVER YOU NEED IT MOVEMENT AND PRESENCE DETECTORS.

---

Be it in [offices](#), [apartment buildings](#) or [homes](#), either [inside](#) or [outside](#), light is synonymous with safety. With FINDER's movement and presence detectors you can have all the light you need, only when you need it. As soon as FINDER detectors sense movement in their area of coverage, they will switch on the lights in the office, corridor, stairwell, garage or garden, to ensure your comfort and safety. With a range comprising 14 different models, FINDER can always provide the right one for you. Whether surface or recessed mounting on walls or ceilings, for internal or external applications, we have [the detector to meet all your requirements](#).

## INTERNAL PRESENCE DETECTORS

Presence sensors, also known as [PIR](#) (PIR – Passive InfraRed) movement detectors, are designed to switch on the light automatically every time the sensor detects **even the slightest movement**. In a crowded room, where lots of people are coming in and out, the motion sensor will continue to detect movement and the light will remain on. It will go off when the last person present moves outside of the sensor's area of survey, and when the time scheduled for the light to remain on has elapsed.

## EXTERNAL MOVEMENT DETECTORS

External movement detectors are designed to be suitable for installation in areas that are exposed to conditions such as dampness, like a garage or basement, or in external areas such as car parks or gardens.

## INTERNAL MOVEMENT DETECTORS

Internal presence detectors are particularly suited for use in bathrooms, corridors, staircases and, more generally, in less heavily transited areas.



WATCH THE VIDEO  
MOVEMENT  
DETECTOR

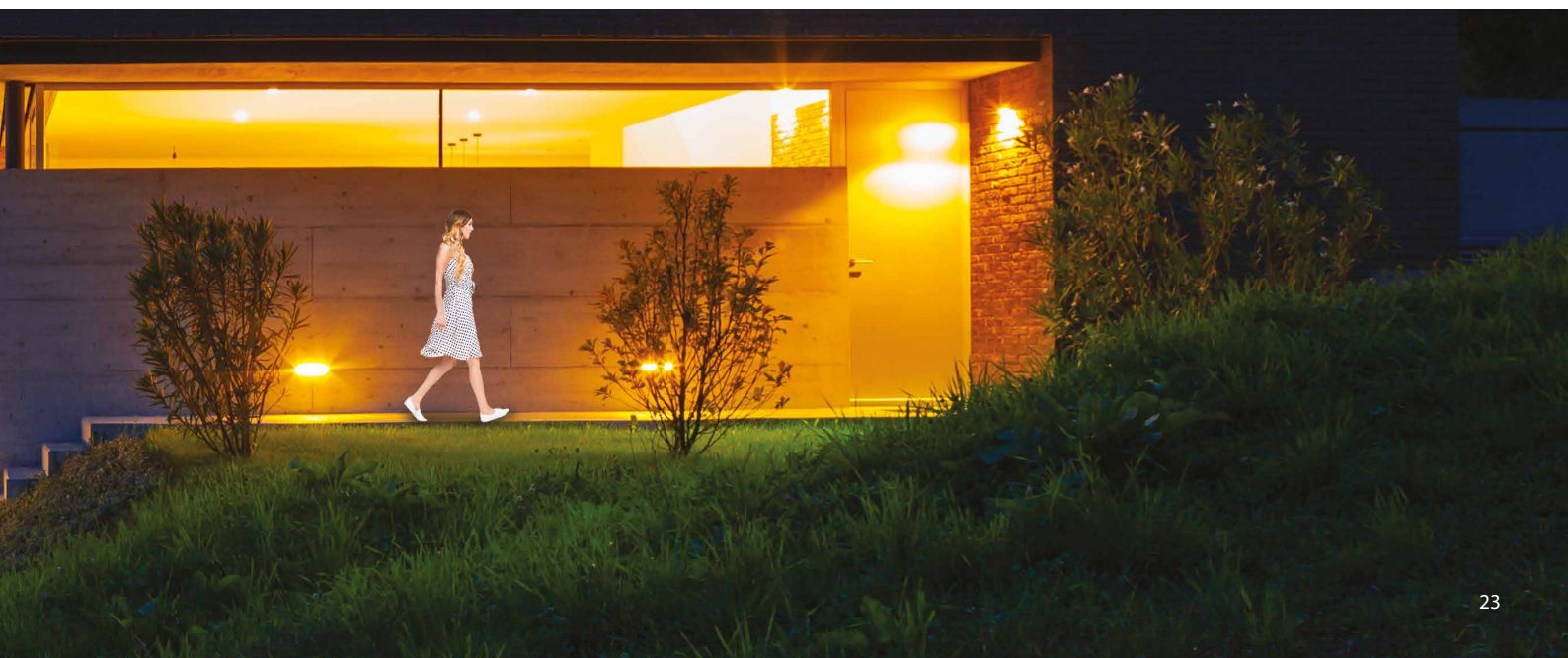

## INTERNAL MOVEMENT DETECTORS FOR CEILING MOUNTING



Type 18.21



Type 18.31



Type 18.41

- Surface or recess mounting
- Suitable for high ceilings (up to 6 metres)
- Suitable for home automation system applications (PLC or BMS)
- Suitable for corridors

## INTERNAL SMART PRESENCE DETECTORS FOR CEILING MOUNTING



Type 18.51  
Surface mount



Type 18.51  
Recess mount



Programmabili e regolabili  
tramite Bluetooth grazie  
all'APP FINDER TOOLBOX.  
Disponibile per iOS e Android.



- Available with an external button to force shutdown
- Responsive lighting brightness to ensure the utmost comfort
- Wide coverage of up to 64 m<sup>2</sup>
- Ability to detect micro-movements
- Available in versions for KNX or DALI home automation systems

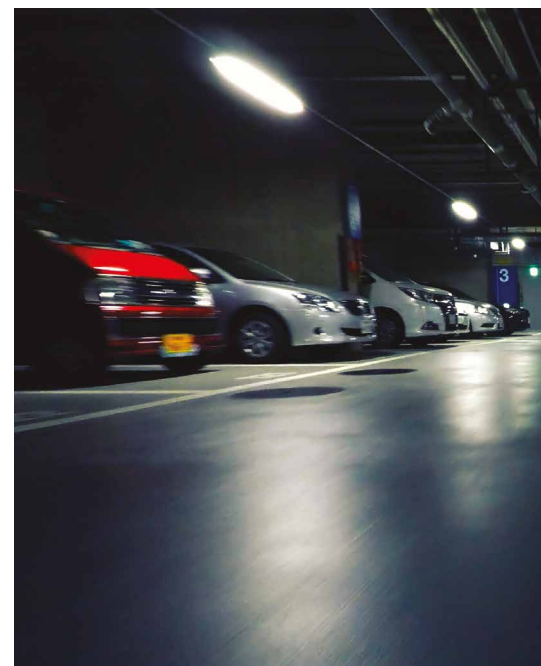

## ADJUSTABLE INTERNAL / EXTERNAL MOVEMENT DETECTORS FOR WALL MOUNTING



- With light dependent sensor and power off delay
- Adjustable swivel action for easy positioning
- Wide area of survey
- IP 54 for internal installation (Types 18.01 and 18.11), independently certified
- IP 55 for external installation (Type 18.A1), independently certified

## INTERNAL MOVEMENT DETECTORS FOR WALL MOUNTING



- Compact design
- Compatible with wall boxes with a diameter of 60mm: 2-module boxes (502) and 3-module boxes (503)
- Type 18.91: the only wall box mounted detector with an integral, completely flat lens
- Type 18.91: compatible with the most widely used residential wiring accessory systems

### ADVANTAGES FOR THE USER



- All the light you need, only when you need it
- Substantial energy savings
- 'Made in Italy' quality and dependability
- Modern, compact and functional design

### ADVANTAGES FOR THE INSTALLER



- Easy to install with PUSH-IN terminals
- Ultra-quick set up with the APP
- Finder quality guaranteed
- For wall or ceiling, surface or recess (60-mm 502 and 503 box) mounting
- Available in BLUETOOTH, KNX and DALI versions for home automation systems

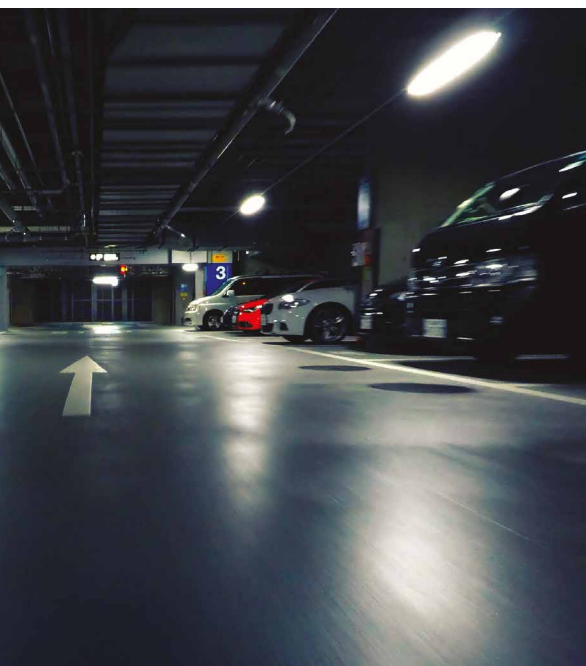

## 14 SERIES. STAIRCASE TIMERS: LIGHT FOR AS LONG AS YOU NEED IT.

The FINDER 14 SERIES staircase timers are designed to control the lighting systems fitted to staircases in houses, apartment blocks and public buildings. Thanks to the range of different functions available, each timer can be configured to meet the specific requirements of each application. Other functions that you may find particularly useful include the 'stair cleaning' maintenance function, which keeps the lights on during cleaning, or the 'power off warning' function, which ensures the lights do not suddenly go off, (but instead are gradually dimmed to give you the chance to press the button again).

### WHY CHOOSE FINDER'S STAIRCASE TIMERS?



#### **SAFETY**

Having the right lighting level in stairwells is not only about comfort, but more importantly it is about being able to go up and down the stairs in complete safety. With the flashing and pre-power-off functions, you will never be left in the dark!



#### **DEPENDABILITY**

Manufactured in Italy and tested up to four times, Finder staircase timers truly are synonymous with reliability.

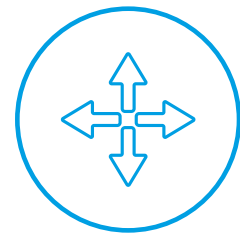

#### **FLEXIBILITY**

8 functions to choose from and an array of configuration options ensure you enjoy the full flexibility of your application.



# 14 SERIES

# MULTIFUNCTION ELECTRONIC STAIRCASE TIMERS.

FINDER's staircase timers offer different degrees of complexity in terms of the functions they can perform. The simpler models, Types 14.81 and 14.91, perform the classic timer function, whereas the more sophisticated models, Types 14.01 and 14.71, are multifunction timers that offer 8 and 3 functions respectively.

## FUNCTIONS

- |  |   |
|--|---|
| <p><b>1.</b><br/>RESETTABLE STAIRCASE TIMER<br/>14.01 - 14.71</p>                | <p><b>2.</b><br/>RESETTABLE STAIRCASE TIMER + MAINTENANCE FUNCTION<br/>14.01 - 14.71</p>                |
| <p><b>3.</b><br/>RESETTABLE STAIRCASE TIMER WITH POWER OFF WARNING<br/>14.01</p> | <p><b>4.</b><br/>RESETTABLE STAIRCASE TIMER WITH POWER OFF WARNING + MAINTENANCE FUNCTION<br/>14.01</p> |
| <p><b>5.</b><br/>TIMING STEP RELAY<br/>14.01</p>                                 | <p><b>6.</b><br/>STEP RELAY TIMER WITH POWER OFF WARNING<br/>14.01</p>                                  |
| <p><b>7.</b><br/>STEP RELAY<br/>14.01</p>  | <p><b>8.</b><br/>LIGHT ON<br/>14.01 - 14.71</p>   |



Type 14.01

Type 14.71

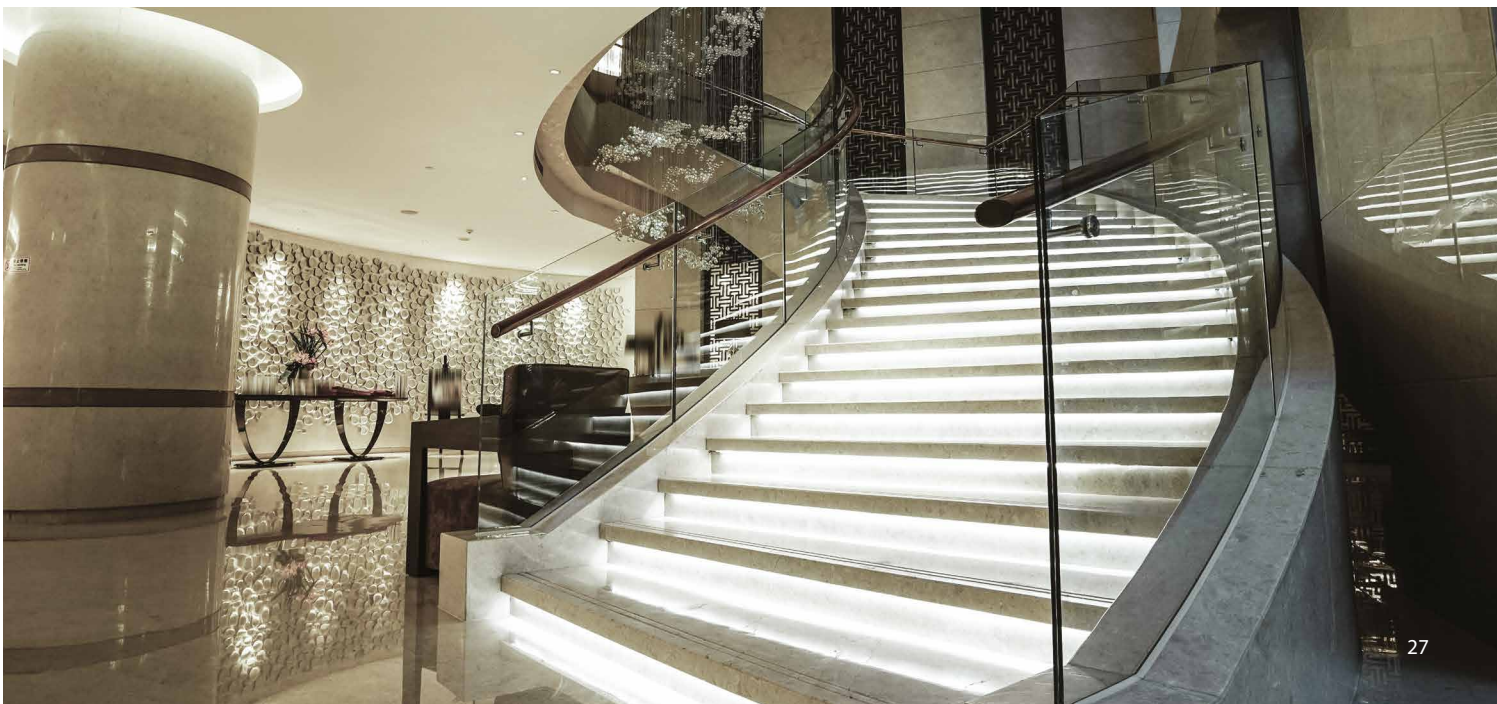



## 15 SERIES.

# FINDER DIMMERS: ADJUST THE LIGHT LEVEL TO ENSURE THE PERFECT AMBIENCE FOR ANY OCCASION.

Being able to dim the lights, or to adjust the brightness, is essential for creating the right ambience in restaurants and hotels, but it is just as important to be able to enjoy comfortable lighting at home. FINDER 15 SERIES dimmers allow you adjust the brightness of each lamp or the entire system to create the perfect ambience.

### WHY CHOOSE FINDER DIMMERS?



#### SAFETY

Finder 15 Series dimmers are designed to protect against overload and short-circuits.



#### COMFORT

Just the right amount of light, as and when you want it: any time of day and in any location. Now that's comfort!

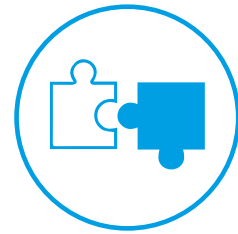

#### VERSATILITY

Finder 15 Series dimmers can dim all types of lamps, including incandescent, halogen, energy-saving bulbs, compact fluorescent light bulbs (CFLs) and LEDs, with all kinds of electromechanical transformers.



## 'MASTER & SLAVE' SYSTEM FOR SINGLE OR COMBINED MULTIPLE DIMMING LOADS.

The 'MASTER & SLAVE' system for dimming was created by Finder to provide a tool that is flexible and powerful, for all those applications requiring the management of a large number of loads. The Master Dimmer Type 15.10 control device generates a 0 – 10 V signal which is proportional to the value of light desired and can adjust the brightness of the lamps when connected to Type 15.11 Slave Dimmers. Each 'Master' can drive up to 32 'Slave' dimmers with a switchable power of 400 W each. The combination of these two products allows you to create that unique lighting ambience.



Master & Slave

Type 15.10 - Type 15.11

### APPLICATIONS

The Master & Slave dimmer system is ideal for commercial environments, such as **restaurants**, **hotels** and **shops**, and more generally, anywhere there is a need to control a large number of lamps with precision.

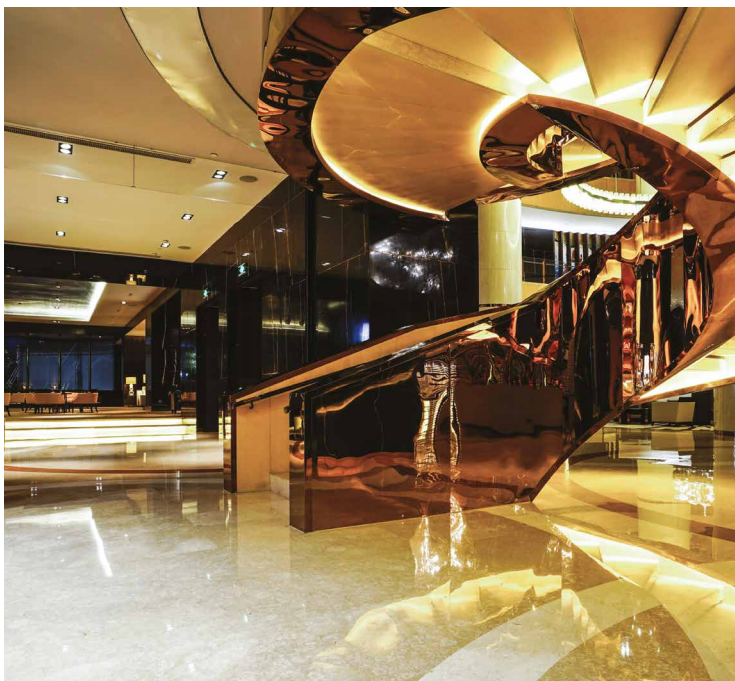

APPLICATIONS

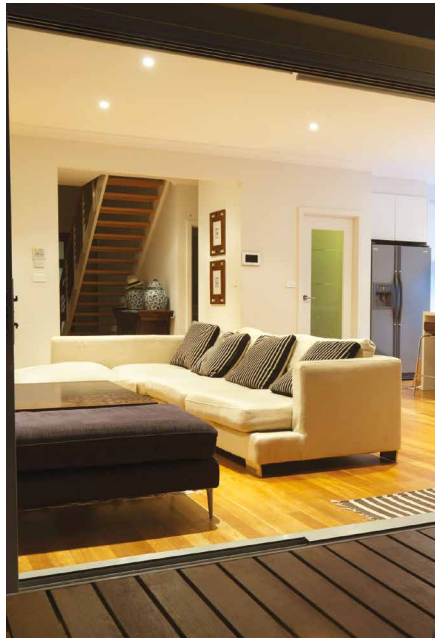

HOUSES  
HOTELS  
CAFÉS  
STAIRCASES  
APARTMENT BUILDINGS  
RESTAURANTS

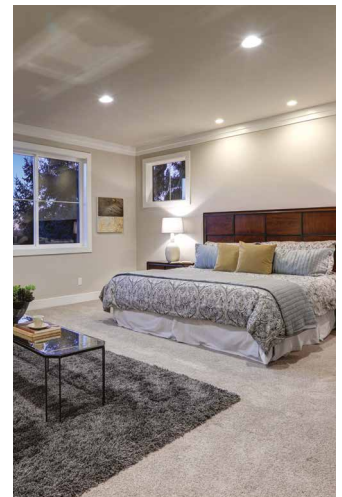
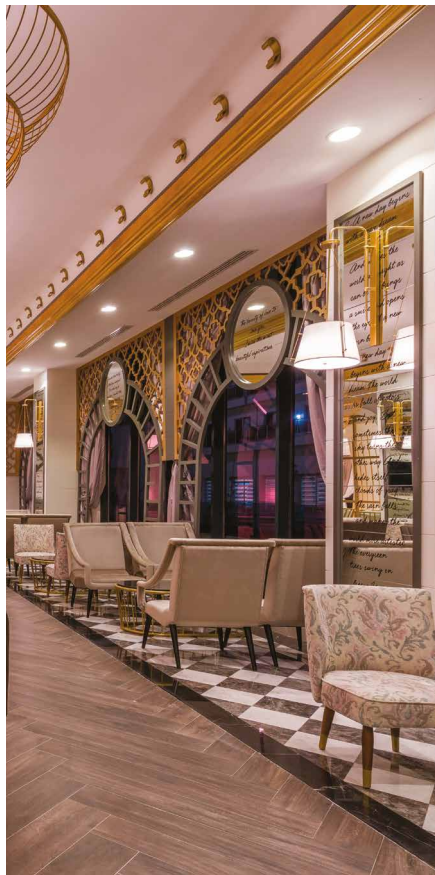

# FINDER 15 SERIES DIMMERS FOR RESIDENTIAL AND COMMERCIAL USE.

## INTEGRATED DIMMERS

**15.91.** Can be installed as a wall box mounted dimmer and integrated with the major residential and commercial wiring accessory systems. The dimmer can control 230V light bulbs, dimmable LEDs from 3 to 50 W and incandescent or halogen bulbs from 3 to 100 W. Adjustment is linear and with the "with memory" function you can also set the system to remember the previously used brightness level. Load adjustment is 'Leading Edge', meaning it is carried out through the blocking of the initial section of the half-wave.



Type 15.91

**15.51.** Is suitable for wall box or panel mounting. It can control dimmable LEDs and incandescent or halogen bulbs up to 400 W. Adjustment can be set to follow a linear or a square-law curve. Load adjustment is the 'Trailing Edge' type, meaning it is carried out through blocking of the end section of the half-wave.



Type 15.51

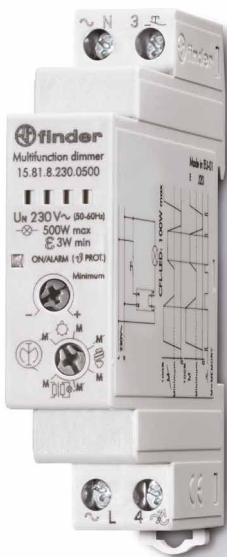

Type 15.81

## PANEL DIMMERS

**15.81.** Is designed for 35 mm rail mounting, this product can even dim energy-saving bulbs, compact fluorescent light bulbs (CFLs) and dimmable LEDs, and works with all types of electromechanical transformers. More functions can be configured for the dimmer to operate with Leading Edge or Trailing Edge settings. It can manage loads up to 500 W.



WATCH THE VIDEO  
15 SERIES  
DIMMER

FINDER CREATES PRODUCTS  
THAT RESPOND ACCORDING TO THE TIME OF  
DAY, THE TEMPERATURE, WATER LEVEL AND  
AMBIENT LIGHTING LEVEL

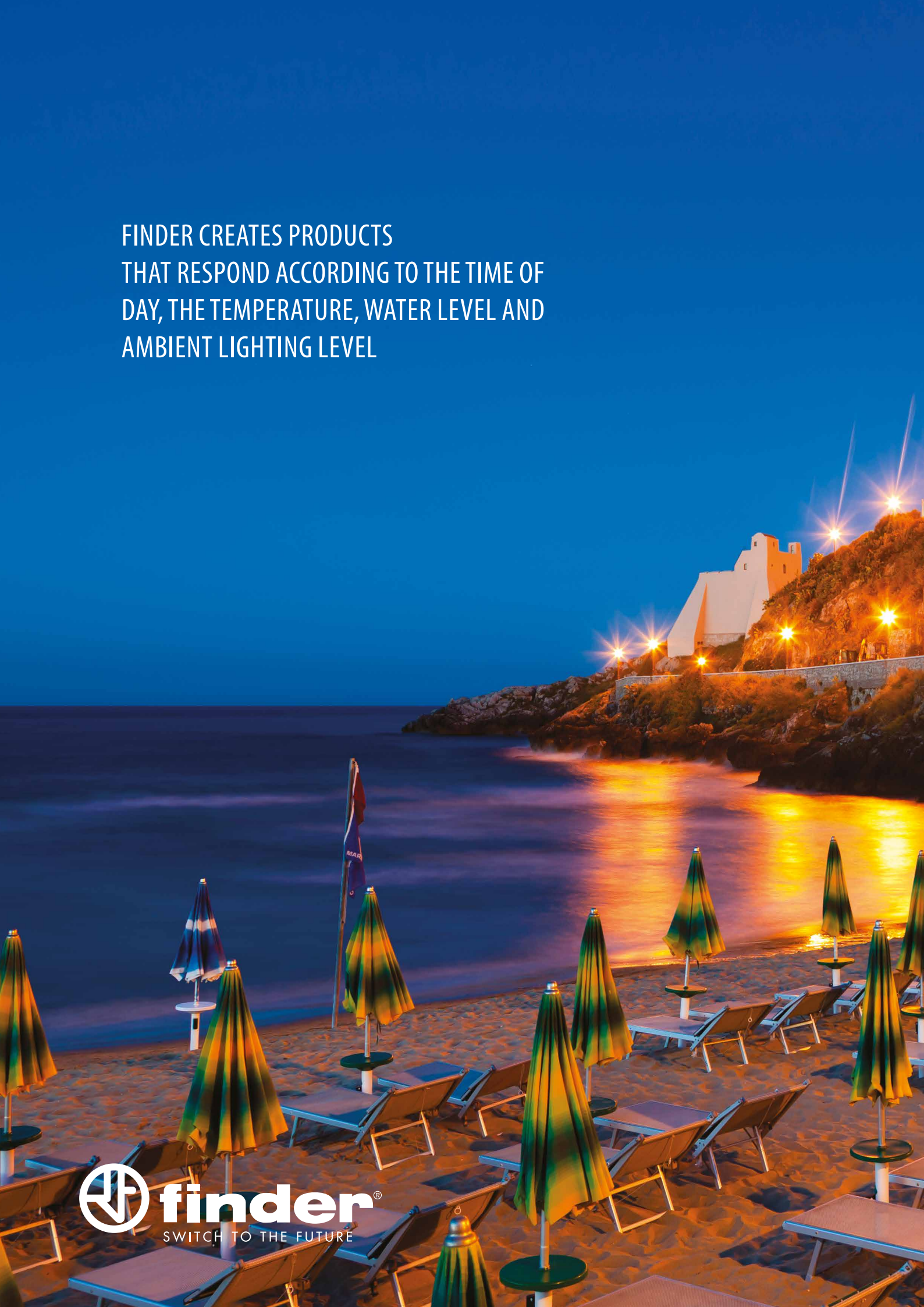



## 10 SERIES.

# LIGHT DEPENDENT RELAYS: SWITCHING LIGHTING ON AND OFF ACCORDING TO THE AMBIENT LIGHT LEVEL.

FINDER's light dependent relays switch the lights on and off depending on the brightness threshold set. This is an energy efficient way of controlling lighting systems such as streetlights.

The relays are available in modular versions for mounting on a 35 mm rail in outline widths of 1 or 2 modules (11 Series) or for mounting on walls or on street lights (10 Series).

### WHY CHOOSE FINDER LIGHT DEPENDENT RELAYS?



#### ENERGY SAVINGS

Finder's light dependent relays only switch on the lights when the level of natural light drops below the brightness value set. This means you can rest assured that you are using light when only strictly necessary.



#### COMFORT

There is no need to schedule the lighting via a timing device because it will switch on as soon as it gets dark. All you need to do is set the switching brightness level threshold, and the deed is done!



#### PRECISION

With several Italian patents to its name, such as the zero hysteresis principle and the light feedback compensation patents, Finder's light dependent relays are extremely accurate devices that can guarantee the highest performance at all times.

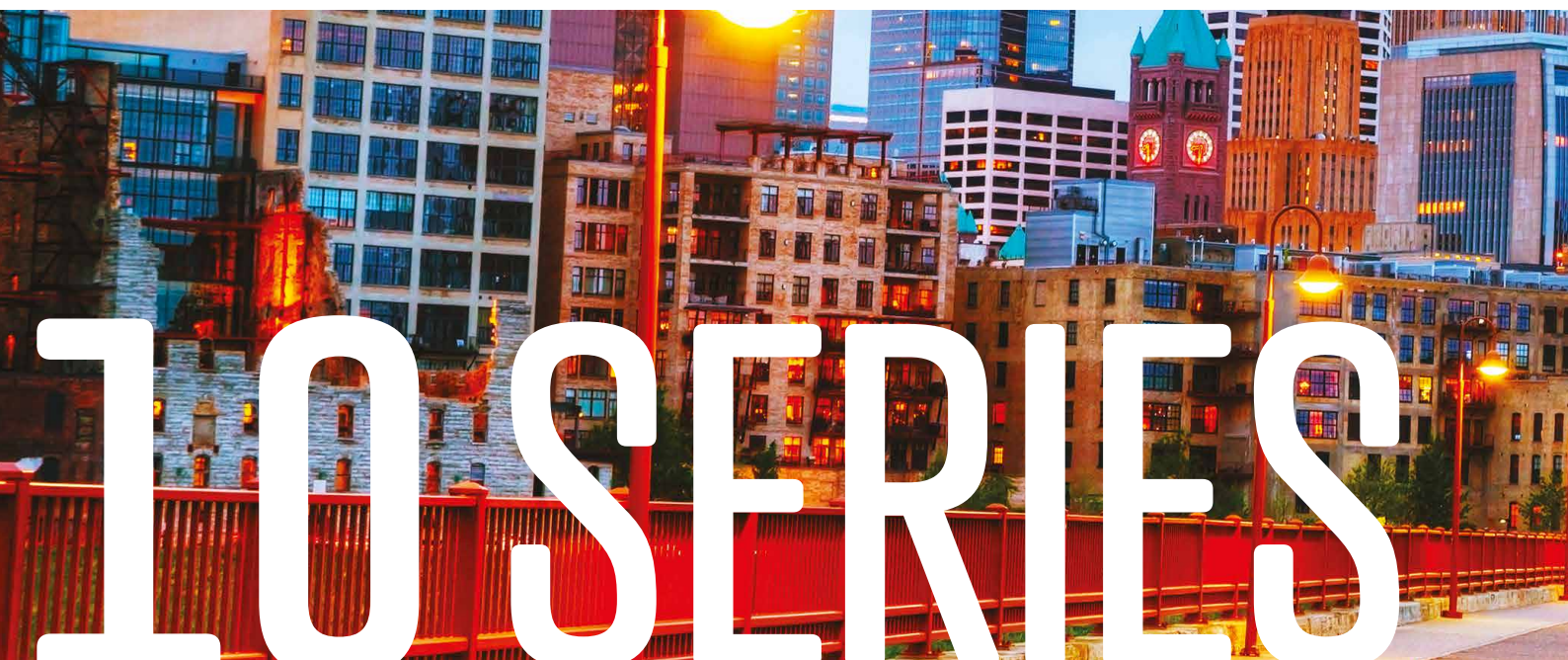

# INNOVATIVE LIGHT DEPENDENT RELAYS WITH INTEGRAL LIGHT SENSORS.

## POLE AND WALL MOUNTING.

The FINDER 10 SERIES light dependent relays with photosensors will switch lights on and off according to the ambient light level. They are designed to be installed on poles or as stand-alone devices, and are therefore particularly suited for street lighting, or to manage lighting in car parks or walkways.



Two Pole output - 2 NO 16 A,  
double pole switching (L+N)

Type 10.32

Single output - 1 NO 16 A,  
single pole switching (L)

Type 10.41



Single output - 1 NO 12A,  
single pole switching (L)

Compact size

Type 10.51



Single output - 1 NO 16 A,  
single pole switching

Type 10.61







# 11 SERIES

# 11 SERIES.

## LIGHT DEPENDENT RELAYS: SWITCHING LIGHTING ON AND OFF ACCORDING TO THE AMBIENT LIGHT LEVEL.

### INSTALLATION WITHIN ELECTRICAL PANEL ENCLOSURES

The FINDER 11 SERIES modular light dependent relays are designed to be installed within electrical panel enclosures in conjunction with a remote light-sensitive sensor. These light dependent relays incorporate two Italian patents: The **zero hysteresis** circuit patent, which ensures that the switch on and switch off both occur at a single lux threshold level, as set – without any hysteresis. The **light feedback compensation** patent minimizes set-up and operational problems by counteracting the effect of the sensor responding to the light emitted from the lighting under control.

These technical refinements ensure the optimum use of electrical power with ease of set-up and operation, making them particularly suited to applications in almost all residential, commercial, public and industrial settings



'ZERO HYSTERESIS'  
Italian patent  
Type 11.41

Two outputs  
Type 11.42



External  
light-sensitive sensor



Digital light dependent  
relay + time switch  
Type 11.91



Compact  
Type 11.31

## 20 - 26 - 27 SERIES.

# ELECTROMECHANICAL STEP RELAYS: THE 'CLICK' THAT'S BEEN SWITCHING THE LIGHTS SINCE 1954.

The FINDER 20, 26 and 27 SERIES bring together various versions of the first product that was patented and manufactured by the company in 1954: the electromechanical step relay. Ever since, the electromechanical step relay has become synonymous with the Finder brand, reliably and effectively demonstrating the quality of our products.

Finder's step relays are perfect devices for any lighting system.

### WHY CHOOSE FINDER'S ELECTROMECHANICAL STEP RELAYS?



#### HISTORY

Over 60 years' experience in manufacturing this type of product today enables us to ensure the highest quality standards.

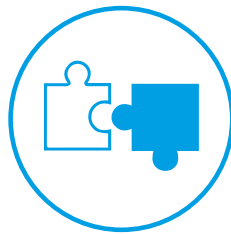

#### VERSATILITY

Finder's range of electromechanical step relays enables you to implement up to 6 sequences for a fully versatile application.



#### CHOICE

A wide range of switching sequences to suit a wide range of requirements and applications.





Modular step relays for  
35 mm rail mounting

Types 20.21 - 22 - 23 - 24 - 26 - 27 - 28



Electromechanical step relays with  
electrically separate coils and contacts

Types 26.01 - 02 - 03 - 04 - 06 - 08



'EVO' electromechanical step relays with  
shared connection between  
coil and contacts

Types 27.21 - 25



**SERIES**

## 13 SERIES. ELECTRONIC STEP RELAYS.

The FINDER 13 SERIES electronic step relays, which are quieter than classic electromechanical step relays. If your system requires a centralised on/off control with just one switch, the electronic step relay is the easiest to install and connect. The 13 Series offers the best choice for a wide variety of applications.

### WHY CHOOSE FINDER'S ELECTRONIC STEP RELAYS?

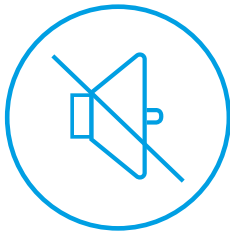

#### NOISELESS

Finder's specially designed electronic step relays are practically silent.



#### DEPENDABILITY

Since its first patent in 1954, Finder has been in the vanguard of the evolution of the step relay, now synonymous with the brand.

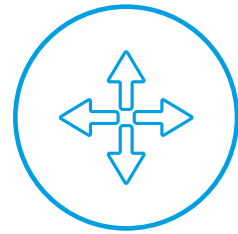

#### FLEXIBILITY

A wide range of switching sequences to suit a wide range of requirements and applications.



# 13 SERIES



Multifunction  
Type 13.61



CALL + RESET  
relay for use in bathrooms,  
hospitals and care homes  
Type 13.11 - Type 13.12



SELV high security between the mains and  
control. Ideal for swimming pools  
Type 13.01



Noiseless step relay  
and timed step relay  
Type 13.91



Noiseless interposing  
monostable relay  
Type 13.31



## 22 SERIES. MODULAR CONTACTORS FOR LARGE LOAD MANAGEMENT.

The FINDER 22 SERIES modular contactors can handle high power for a wide range of electrical systems, machinery and devices. They are often chosen to manage power in hotel rooms and passenger cabins on cruise ships. This is because they ensure high performance with quiet operation: the perfect combination to guarantee guests' comfort. The wide range of voltages and options available allows you to configure the product to the specific requirements of your application.

### WHY CHOOSE FINDER MODULAR CONTACTORS?

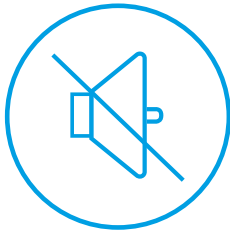

#### NOISELESS

For effective, discreet load management in areas such as hotel rooms and passenger cabins on cruise ships.



#### PERFORMANCE

Broad spectrum of controllable loads, with nominal current ratings from 25 to 63 A.



#### CONFIGURATION

The contactors can be configured to meet a wide range of requirements and applications.



# MODULAR POWER CONTACTORS.

Modular power contactors can not only control lighting circuits in residential/service/commercial and industrial environments, but can also manage resistive and inductive circuits such as engines, pumps and fans. These modular power contactors are available in several multi-pole versions, with nominal currents between 25 and 63 A, and maximum inrush currents between 80 and 240 A.

## 25 A

WIDE RANGE OF DIFFERENT AND VERSIONS AND OPTIONS – FOR PEAK CURRENTS BETWEEN 80 AND 120 A

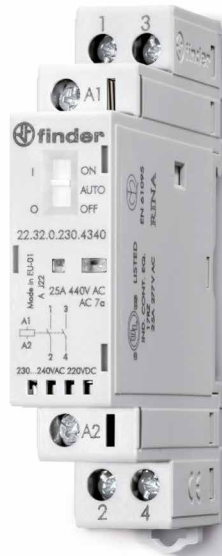

Type 22.32



Type 22.34

## 40 A



PEAK INRUSH CAPABILITY UP TO 176 A

Type 22.44

## 63 A



PARTICULARLY SUITED TO INDUSTRIAL LAMP LOADS WITH PEAK INRUSH CURRENTS UP TO 240 A

Type 22.64

## 800 W

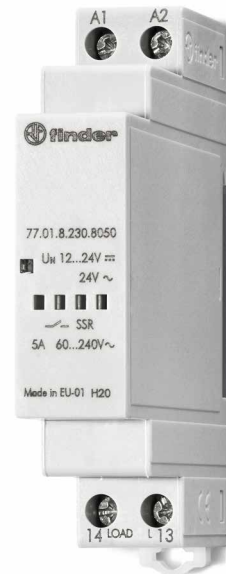

IDEAL FOR LED LOADS UP TO 800W

Type 77.01



## 78 SERIES. LOW PROFILE, HIGH-PERFORMANCE SWITCH MODE POWER SUPPLIES.

The FINDER 78 SERIES switch mode power supplies are ideal for LED strips, video door entry systems and home automation systems.

They stand out for their high standards of workmanship, 100% MADE IN ITALY, as well as an array of functions including: the front panel replaceable fuse for input protection, a compact design, and a very low energy use when in stand-by mode. The Types 78.51 and 78.61 models also have characteristics specifically intended for battery charging. They are ideal for supplying emergency lights, CCTV systems and access control systems.

### WHY CHOOSE FINDER SWITCH MODE POWER SUPPLIES?



#### DEPENDABILITY

Each power supply is subject to a series of rigorous tests before leaving the factory. This is the way we guarantee that you can fully trust our products. Finder power supplies are protected against overloading and short-circuiting.



#### PERFORMANCE

Finder power supplies are built to provide top-of-the-range performance in terms of efficiency and low energy use.



#### CONFIGURATION

The output of the power supply can be adjusted to meet the requirements of the application.



# 78 SERIES



**12 W**  
NOMINAL  
OUTPUT  
POWER

Type 78.12



**36 W**  
NOMINAL  
OUTPUT  
POWER

Type 78.36



**50 W**  
NOMINAL  
OUTPUT  
POWER

Type 78.50/51



**60 W**  
NOMINAL  
OUTPUT  
POWER

Type 78.60/61



FINDER: AN ITALIAN BRAND WITH A WORLDWIDE PRESENCE  
HELPING BUSINESSES AND PROFESSIONALS IN LIGHTING  
MANAGEMENT FOR OVER 60 YEARS





 **FINDER SpA**  
Via Drubiaglio 14  
I-10040 ALMESE (TO)  
Tel. +39 011 9346 211  
Fax +39 011 9359 079  
[export@findernet.com](mailto:export@findernet.com)

 **FINDER FRANCE Sarl**  
Avenue d'Italie  
ZI du Pré de la Garde  
F - 73300 ST. JEAN DE MAURIENNE  
Tel.+33/479/83 27 27  
Fax +33/479/59 80 04  
[finder.fr@finder.fr](mailto:finder.fr@finder.fr)

 **FINDER GmbH**  
Hans-Böckler-Straße 44  
D - 65468 Trebur-Astheim  
Tel. +49 6147 2033-0  
Fax +49 6147 2033-377  
[info@finder.de](mailto:info@finder.de)

 **S.P.R.L. FINDER BELGIUM B.V.B.A.**  
Bloemendael, 5  
B - 1547 BEVER  
Tel. +32/54/30 08 68  
Fax +32/54/ 30 08 67  
[finder.be@findernet.com](mailto:finder.be@findernet.com)

 **FINDER P.L.C.**  
Opal Way - Stone Business Park  
STONE, STAFFORDSHIRE  
ST15 0SS - UK  
Tel: +44 (0)1785 818100  
Fax: +44 (0)1785 815500  
[finder.uk@findernet.com](mailto:finder.uk@findernet.com)

 **FINDER RELAIS NEDERLAND B.V.**  
Dukdalfweg 51  
1041 BC AMSTERDAM - NEDERLAND  
Tel. +31/20/615 65 57  
Fax +31/20/617 89 92  
[finder.nl@findernet.com](mailto:finder.nl@findernet.com)

 **FINDER AB**  
Sångelekgatan 6c  
SE - 215 79 Malmö  
Tel: +46 (0) 40 93 77 77  
Fax: +46 (0) 40 93 78 78  
[finder.se@findernet.com](mailto:finder.se@findernet.com)

 **FINDER RELAIS VERTRIEBS GmbH**  
IZ NÖ-Süd, Str. 2a, Obj. M 40  
A - 2351 Wiener Neudorf  
Tel. +43/2236/86 41 36 - 0  
Fax +43/2236/86 41 36 - 36  
[finder.at@findernet.com](mailto:finder.at@findernet.com)

 **FINDER CZ, s.r.o.**  
Radiová 1567/2b  
CZ - 102 00 PRAHA 10  
Tel. +420 286 889 504  
Fax +420 286 889 505  
[finder.cz@findernet.com](mailto:finder.cz@findernet.com)

 **FINDER Aps**  
Bøstrupvej 11  
DK-8870 Langå  
Tel. +45 69 15 02 10  
Fax +45 69 15 02 11  
[finder.dk@findernet.com](mailto:finder.dk@findernet.com)

 **FINDER ELECTRICA S.L.U.**  
C/ Severo Ochoa, 6  
Pol. Ind. Cap de L'Horta  
E - 46185 La Pobla de Vallbona (VALENCIA)  
Apdo Postal 234  
Telf. Oficina Comercial 93 836 51 30  
[finder.es@findernet.com](mailto:finder.es@findernet.com)

 **FINDER - Hungary Kereskedelmi Kft.**  
Kiss Ernő u. 3/A.  
HU - 1046 BUDAPEST  
Tel. +36/1-369-30-54  
Fax +36/1-369-34-54  
[finder.hu@findernet.com](mailto:finder.hu@findernet.com)

 **FINDER PORTUGAL LDA**  
Travessa Campo da Telheira, n. 56  
Vila Nova da Telha,  
P - 4470-828 - MAIA  
Tel. +351 22 99 42 900 -1-6-7-8  
Fax +351 22 99 42 902  
[finder.pt@findernet.com](mailto:finder.pt@findernet.com)

 **FINDER (Schweiz) AG**  
Industriestrasse 1a Postfach 23  
CH - 8157 DIELSDORF (ZH)  
Tel. +41 44 885 30 10  
Fax +41 44 885 30 20  
[finder.ch@finder-relais.ch](mailto:finder.ch@finder-relais.ch)

 **FINDER RELAYS, INC.**  
4191 Capital View Drive  
Suwanee, GA 30024 - U.S.A.  
Tel. +1/770/271-4431  
[finder.us@findernet.com](mailto:finder.us@findernet.com)

 **FINDER ECHIPAMENTE srl**  
Str. Clujului nr. 75 F,  
401180 Turda  
Jud. CLUJ - ROMANIA  
Tel. +40 264 403 888  
Fax +40 264 403 889  
[finder.ro@finder.ro](mailto:finder.ro@finder.ro)

 **RELEVADORES FINDER, S.A. de C.V**  
Carretera a San Bernardino Chalchihuapan #43  
San Pablo Ahuatempan, Santa Isabel Cholula, Puebla.  
C.P. 74350 - MÉXICO.  
Tel. +52/222/2832392, 2832393, 2832394  
Fax. +52/222/7628471  
[finder.mx@findernet.com](mailto:finder.mx@findernet.com)

 **FINDER OOO**  
Bakuninskaya street, 78/1  
105082 MOSCOW  
RUSSIAN FEDERATION  
Tel. +7/495/229-49-29  
Fax +7/495/229-49-42  
[finder.ru@findernet.com](mailto:finder.ru@findernet.com)

 **FINDER COMPONENTES LTDA.**  
Rua Olavo Bilac, 326  
Bairro Santo Antônio  
São Caetano Do Sul - São Paulo  
CEP 09530 - 260 - BRASIL  
Tel. +55 11 4223 1550  
Tel. +55 11 2147 1550  
Fax +55 11 4223 1590  
[finder.br@findernet.com](mailto:finder.br@findernet.com)

 **FINDER ARGENTINA**  
Calle Martín Lezica 3079  
San Isidro - Buenos Aires  
CP B1642GJA - ARGENTINA  
Tel +54/11/5648.6576  
Fax +54/11/5648.6577  
[finder.ar@findernet.com](mailto:finder.ar@findernet.com)

 **FINDER ASIA Ltd.**  
Room 901 - 903, 9F, Premier  
Center20 Cheung Shun Street  
Cheung Sha Wan, Kowloon  
Hong Kong  
Tel. +852 3188 0212  
Fax +852 3188 0263  
[finder.hk@findernet.com](mailto:finder.hk@findernet.com)

 **FINDER Polska Sp. z o.o.**  
ul. Malwowa 126  
PL - 60-175 Poznań  
Tel. +48 61 865 94 07  
Fax +48 61 865 94 26  
[finder.pl@findernet.com](mailto:finder.pl@findernet.com)

 **FINDER INDIA PVT. LTD.**  
Unit No.912 - R.G. Trade Tower,  
Netaji Subhash Place,  
Wazirpur District Centre,  
Pitampura - Delhi - 110034 - INDIA  
Tel. +91-11-47564343  
Fax +91-11-47564344  
[finder.in@findernet.com](mailto:finder.in@findernet.com)

**Technical assistance**  
[support@findernet.com](mailto:support@findernet.com)

Follow us:



